

NOVA LUCE

9620145

1

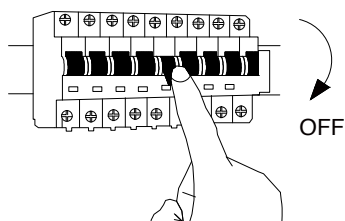

Turn off the general switch

2

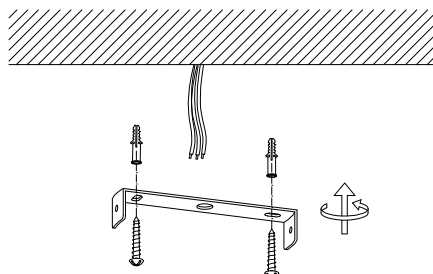

Drill holes
Apply plastic anchors with screws

3

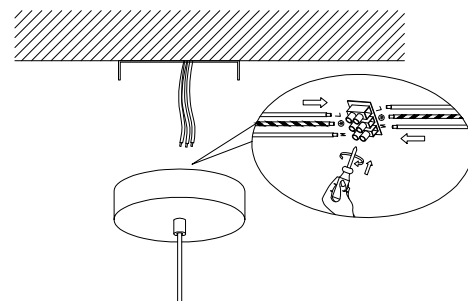

Connect the wires

4

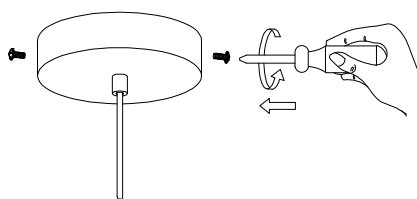

Apply side screws to make it stable

5

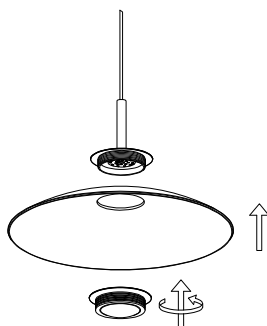

Apply the glass & the cap
into place to make it stable

6

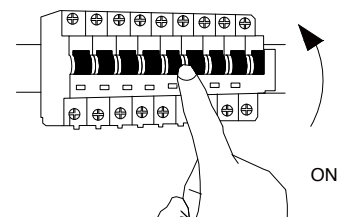

Turn on the general switch

